

正面図

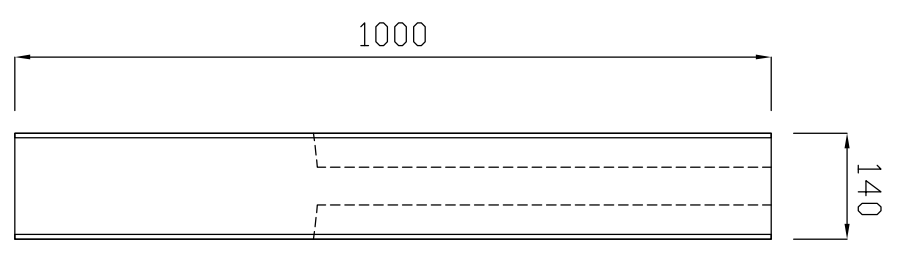

側面図

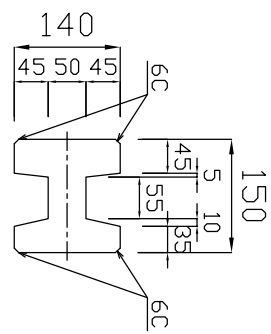
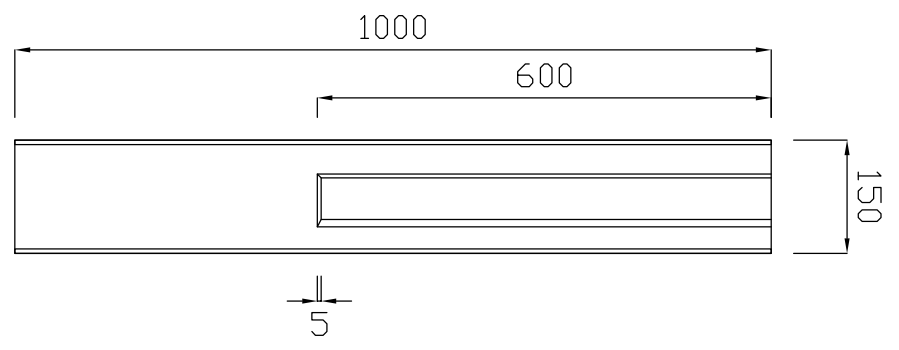

土留め板は柵板を使用

参考質量42kg

製品名	杭式土留め柱	縮尺	1:10
規格	H=1000 2段		