

正面図

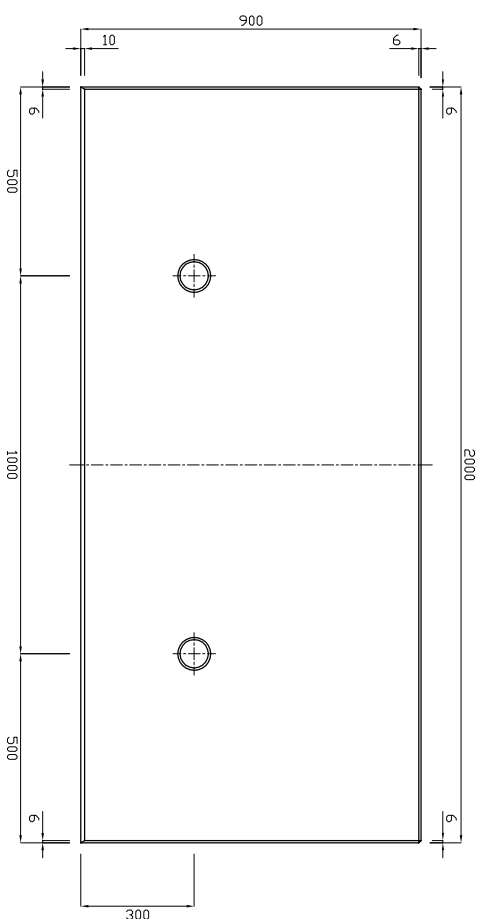

断面図

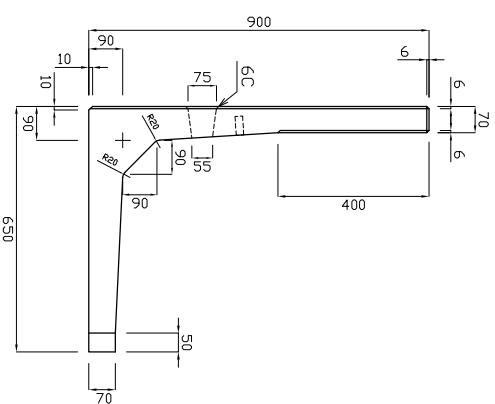

背面図

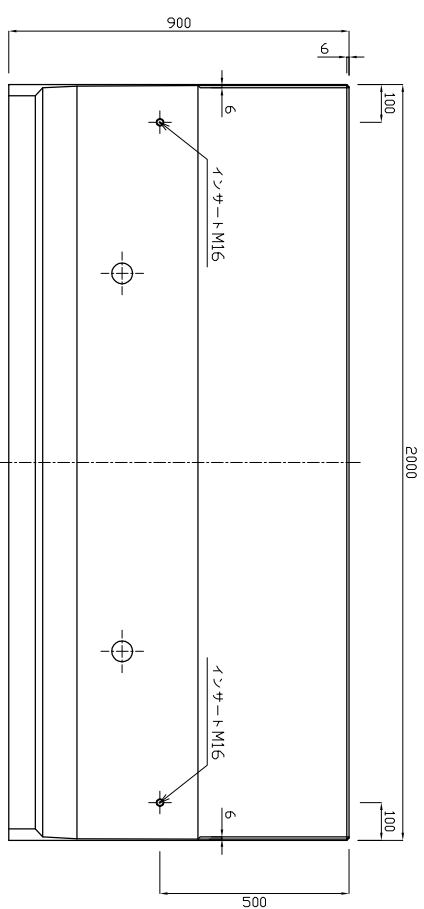

底版図

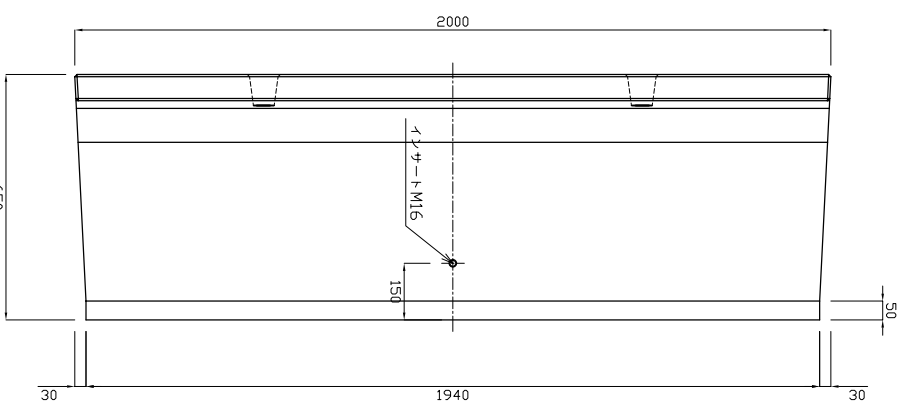

参考重量560kg

製品名	L型擁壁 直角 3.5kN	縮尺	1 : 20
規格	H=900 B=650 L=2000		



新生興産株式会社

SHINSEI KOSAN CO., LTD